

## TESS-200A

• OVERVIEW

A reimagined design icon—empowering creativity to redefine modern architecture with timeless beauty.

By Rudolph Schelling Webermann (RSW®), an award-winning German firm, this Tessera Collection model celebrates the precision of Islamic motifs with a three-block modular system. Designed for versatility, it allows architects to craft intricate, dynamic compositions that honor tradition while embracing modern design.



• MODEL

Each Jonite product model represents a unique combination of design, durability, and precision engineering, tailored to meet diverse architectural requirements.

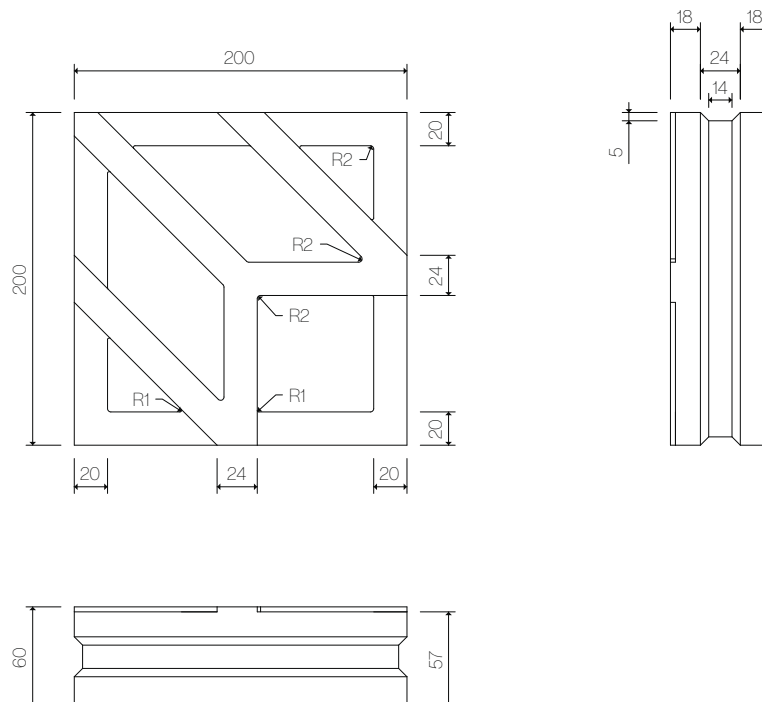

• TECHNICAL INFORMATION

DIMENSIONS

W: 200mm  
L: 200mm  
H: 60mm

OPEN AREA

17021 mm<sup>2</sup> (43%)

COMPRESSIVE STRENGTH

60 MPa

WEIGHT

3.3 kg





• APPLICATIONS

Crafted for both aesthetic expression and functional performance, Jonite breeze blocks offer a unique way to sculpt space with purpose.

From façades and feature walls to courtyard screens and garden partitions, each piece allows light and air to pass through while offering privacy and structural definition. Ideal for indoor or outdoor use, Jonite breeze blocks are modular elements that bring form and function together beautifully.

• TESTING & COMPLIANCE

Jonite products undergo stringent quality testing to ensure they meet international standards, providing reliable performance and safety across various applications.

TEST	STANDARD	RESULT	APPLICATIONS
 Surface Spread of Flame	BS 476 Part 7	Class 1	Complies with fire safety for indoor or facade applications.
 Salt Spray Test	ASTM B117	No red rust or visible changes after 48h	Suitable for most outdoor environment.
 Water Absorption	SS245:1995	0.09%	Ensures long-term durability in wet and dry outdoor environments.
 Compressive Strength	ASTM C140 / 140M-24a	60.4 N/mm <sup>2</sup> (Average)	Suitable for load-bearing or structural architectural applications.

• INTEGRITY & SUSTAINABILITY

Every Jonite product is created with eco-conscious practices, combining long-lasting durability with sustainable design to reduce environmental impact.

REGULATIONS



RECOGNITION



• CONFIGURATIONS

Interchangeable units in this breeze block collection allow for diverse configurations. Easily create unique patterns, facades, or screens to match any design vision.

Elevate your design projects by leveraging the ability to mix and match these units with our comprehensive range of breeze block collections. Witness the possibilities with these configuration examples:

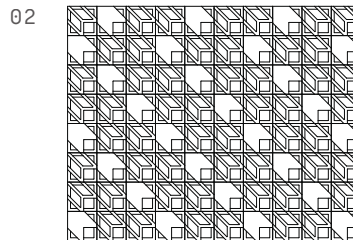
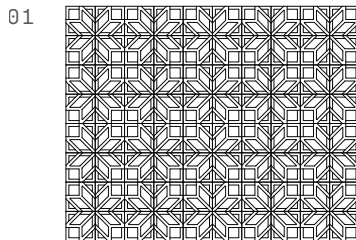

Features Tessera Collection's TESS-200A and TESS-200C.

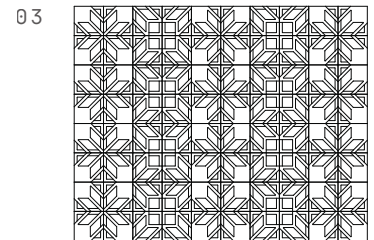

Features Tessera Collection's TESS-200A and TESS-200B.

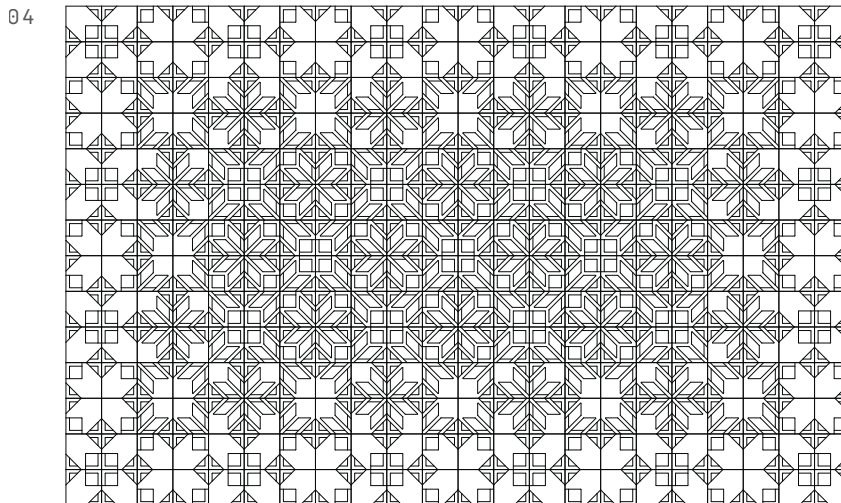

Features Tessera Collection's TESS-200A, TESS-200B and TESS-200C.

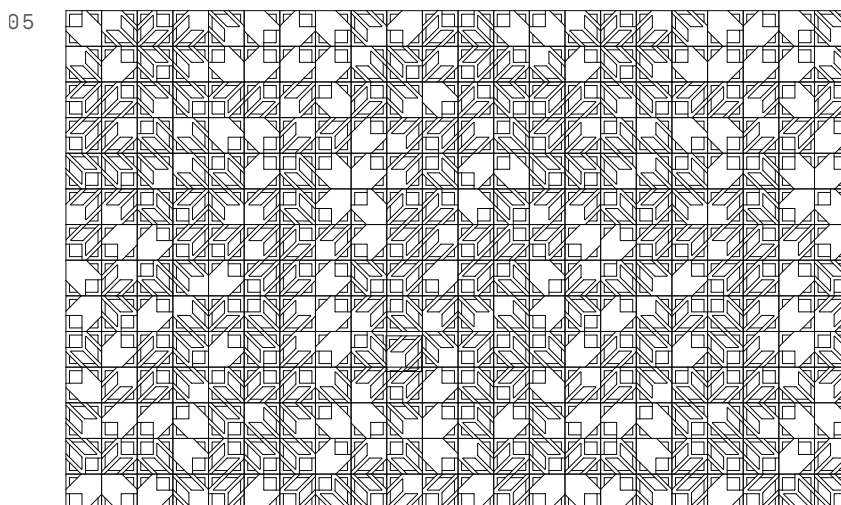

Features Tessera Collection's TESS-200A, TESS-200B and TESS-200C.